

...the mark of perfection™

***...In Pursuit
of Perfection***

Pursuing Perfection

Patented Design Innovation

- Patent No. 5,553,596, (VIBRA-CUSH™) Crossbow Vibration Damping Device
- Patent No. 5,598,829, (DFI™) Crossbow Dry Fire Prevention Device
- Patent No. 5,649,520, (PowerTouch™ Trigger) Crossbow Trigger Mechanism
- Patent No. 5,987,724, (SuperBrite™) Crossbow Bolt Cap and Fletching Nock Device and Method
- Patent No. 6,095,128, (ACUdraw™) Crossbow Bowstring Drawing Mechanism
- Patent No. 6,286,496 B1, (ACUdraw™) Crossbow Bowstring Drawing Mechanism

Superior Components & Materials

- Aircraft grade machined aluminum
- Aircraft grade extruded aluminum
- Investment castings
- Hardcoated & Teflon® impregnated aluminum surfaces
- Pultruded Fiberglass Limbs
- Engineered Polymer Components
- Fast Flight™ Strings & Cables
- Stainless Steel Assembly Screws

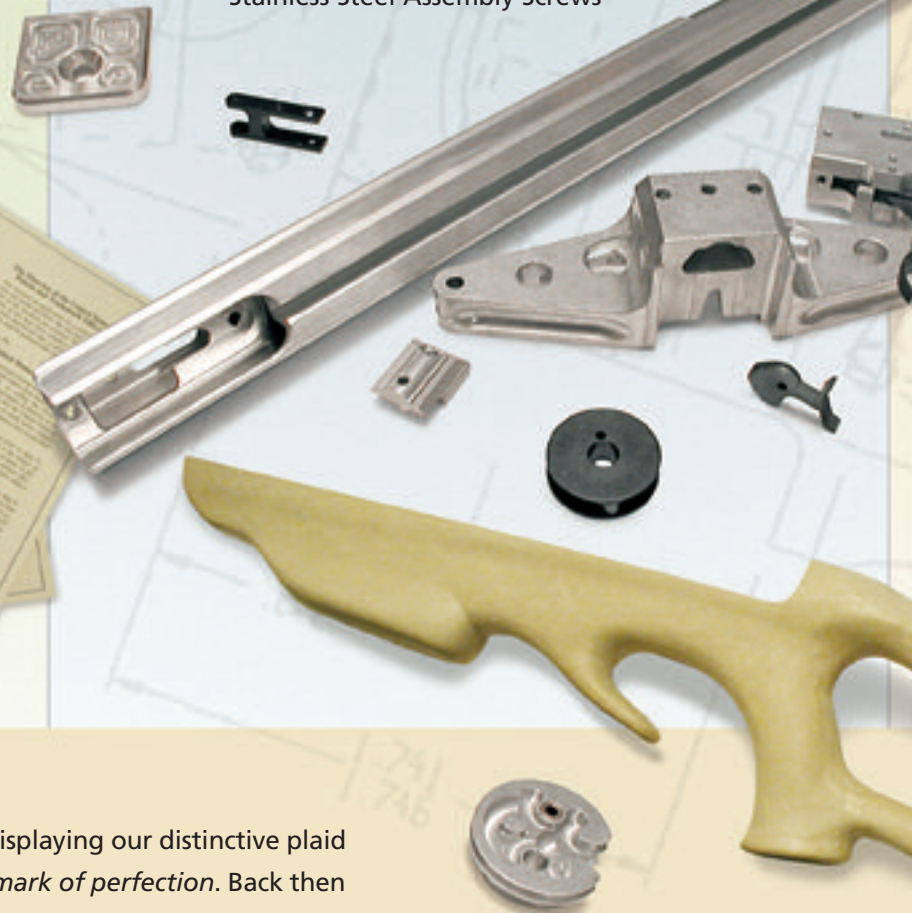

...the mark of perfection™

We started our company in January 1994, proudly displaying our distinctive plaid logo, underscored with our company slogan, *...the mark of perfection*. Back then the slogan was a statement of intention – what we wanted to achieve. Today, we focus our product development energy toward... *the pursuit of perfection*. There are three components to that focus: patented design innovation, superior components & materials, and advanced manufacturing methods.

Through...

Advanced Manufacturing Methods

- CNC Machining
- Injection Molding
- Precision Laser Cutting
- Laser Engraved Graphics
- Investment Casting
- Fluid Imaged Camouflage
- State-of-the Art Surface Coating



Core Performance Features

The Foundation Of Every Crossbow We Make.

Every TenPoint™ crossbow is made with the core performance features listed below. These features insure accuracy, dependability, and overall performance from model to model.

While our top-of-the-line models (TURBO Extreme,™ MAGNUM X-2,™ & STEALTH X-2™) include additional features and offer more power and speed, all models are equally dependable and accurate.

Core Performance Features

- Patented VIBRA-CUSH®
- Patented DFI™
- Advanced Quad-Limb Technology
- CNC Machined Components
- Tunable Synthetic Cable Yokes
- NEW - Machined Barrel Flight Deck
- ACRA-ANGLE™ Barrel
- FST IV™ Stock
- Power Limb-Tip Caps™
- Ambidextrous Safety
- Aluminum Foot Stirrup

See the following spread for detailed descriptions of the core performance features



...the mark of perfection™

Warranty

All TenPoint™ crossbows carry a Limited Lifetime Operational Warranty. The only way you will ever have to buy another one is if you just can't stop yourself.

TenPoint Crossbow Technologies™

The Industry Standard For Design, Performance And Durability.

- 1** Lightweight aluminum foot stirrup with sound-dampening rubber coating.
Note: Coating not included on WoodsMan Plus™ and TITAN™ models.
- 2** Lightweight, thin-line machined aluminum pivoting limb pockets.
Note: WoodsMan Plus™ and TITAN™ limb pockets are bolted to the riser in a fixed position.
- 3** VIBRA-CUSH® *patented* bow-to-barrel mounting system. Dramatically reduces vibration and noise level, making TenPoint™ crossbows the quietest on the market.
- 4** Lightweight machined aluminum riser cut to exacting tolerances. Includes locking setscrew system for the main assembly bolt and limb bolts. TenPoint™ bow assemblies do not vibrate loose.
- 5** Limb-bolt locking setscrews.
- 6** ST™ Limb System. The best crossbow limbs ever made. Available only on the STEALTH X-2™, MAGNUM X-2™ & TURBO Extreme™ models. Incredibly smooth and reliable, this unique four-limb design reduces recoil and noise while its powerful stroke

delivers unequalled speed and kinetic energy per inch of power stroke.

Note: WoodsMan Plus™ & TITAN™ models feature our TL-4™ high performance, advanced quad-limb system.

- 7** Power Limb-Tip Caps™ Provide additional tip strength and improved limb performance.
- 8** Precision CNC machined aluminum wheels.
- 9** Synthetic cable yokes for the ultimate in tunability and stability.
- 10** ACRA-ANGLE™ barrel. Extruded aluminum design features angled sides to prevent finger injury and to insure precision loading. TenPoint's™ TURBO Extreme™, MAGNUM X-2™, and STEALTH X-2™ barrels are hard-coated to a 65 Rockwell finish and Teflon® impregnated, reducing wear and string friction and increasing arrow speed. All other models are black anodized.
- 11** ACRA-ARROW™ retention spring. Extra long to enhance arrow flight. Tip is coated to reduce vibration noise.

- 12** DFI™ System. *Patented* Dry-Fire-Inhibitor prevents an accidental dry-fire when no arrow is loaded.
- 13** CLAWOVER™ String Catch. Releases from above the string rather than below it like most crossbows. Allows the string to travel the flight deck vibration-free, insuring stable, accurate arrow flight.
Note: The TITAN™ models use a conventional string catch that releases from below the string.
- 14** Ambidextrous safety. Moves from "fire" (red dot) to "safe" (white dot) when you cock the crossbow.
Note: The TITAN™ models' safety is also ambidextrous and is operated by a unique single plunger located at the rear of the trigger housing.
- 15** PowerTouch™ *patented* trigger. Precision machined to exacting standards, it is recognized as the finest crossbow trigger made today. The trigger's travel is set for optimum release efficiency



— These Items are exclusive to or were first introduced by TenPoint Crossbow Technologies™

and maximum safety, and offers the lightest and smoothest trigger pull in the industry.

Note: The TITAN™ models feature a machined, conventional trigger action with a remarkably crisp release and unique ambidextrous plunger safety.

- 16** FST IV™ Stock. Shorter and lighter, this functionally superior thumbhole design features a higher cheek piece for improved comfort and accuracy and a larger foregrip for better stability and greater safety.
- 17** ACUdraw™ *patented* Integrated Automated Cocking Unit. When operated by a hand crank, the ACUdraw converts the crossbow's draw weight to a mere 5 lbs., making crossbow hunting accessible to anyone who cannot draw 150 lbs. or higher. Also assures precision loading every time. Available as a stock-option on all models, it also can be retrofitted to any TenPoint™ crossbow after purchase.
- 18** Thumb-operated RangeMaster® Sight Adjustment Mechanism. By simply moving the thumb-operated lever from one position to another, you can adjust your yardage without ever taking your eye off the scope. Features a tension-adjustment setscrew and a lock-down thumbscrew system.

The RangeMaster® system is not included on the WoodsMan Plus™ & TITAN™ crossbow models, which feature fixed sight-bridge designs. A Dovetail Fixed Position Accessory (HCA-074) for the adjustable RangeMaster® system is available as an option on the STEALTH X-2™; TURBO Extreme™ and MAGNUM X-2™. It allows you to convert the adjustable sight mount to a fixed sight mount.

- 19** RangeMaster® tension adjustment screw. The mechanism's lock-down thumbscrew, used to hold the RangeMaster® Sight Adjustment Mechanism at whichever yardage setting you select, is located directly opposite the RangeMaster's® tension adjustment screw on the other side of the trigger box.
- 20** Illuminated Red Dot Scope. Available as an accessory on any model or as a stock-option on our TURBO Extreme™, MAGNUM X-2™, & STEALTH X-2™ models. The finest scope and crossbow combination available. When these models are ordered without the Red Dot scope, they do not include a peep and pin sighting system. You must purchase peep and pin conversion accessories to use pin sights.

- 21** A machined aluminum 7/8" Adjustable Dovetail Sight Mount is standard on all STEALTH X-2™, MAGNUM X-2™, and TURBO Extreme™ models. Integrated to work with the RangeMaster® Rear Sight Adjustment Mechanism, it includes an adjustment screw (and locking setscrew) to regulate and micro-tune the dovetail elevation angle. WoodsMan Plus™ and TITAN™ crossbows have a fixed sight bridge that will accept an optional Fixed 7/8" Dovetail (HCA-078).
- 22** TenPoint's™ XX75 2219, 20-inch Easton® Aluminum crossbow shaft, the recommended shaft for all TenPoint crossbows. TenPoint™ is an Easton® Complete Crossbow Arrow Resource™, carrying a complete line of custom crossbow arrows for the entire crossbow industry.
- 23** The main assembly bolt's locking setscrew and the foot stirrup's two attachment setscrews are out of view, located on the underside of the crossbow's riser.
- 24** Sling swivel studs are standard equipment on all models.
- 25** TenPoint's™ 4/5 Arrow Instant Detach Quiver mounts under the riser and quickly locks in place with a couple easy turns of two lock-down knobs.
- 26** New Archery Products® Thunderhead 125® fixed-blade broadhead, featured along with NAP's Spitfire 125® mechanical blade broadhead in most of TenPoint's™ accessory packages.

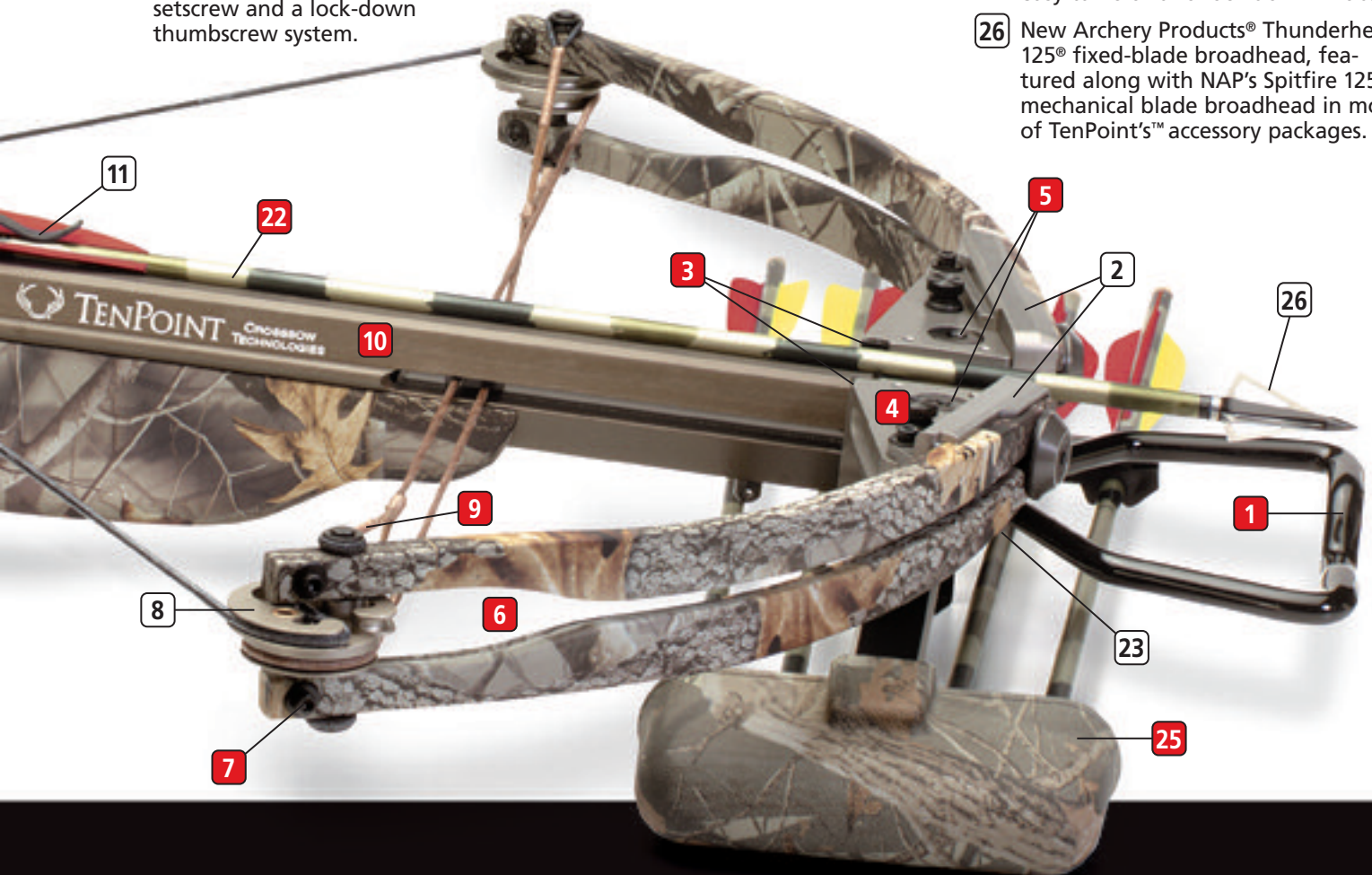

ACUdraw

Making Bowhunting Accessible to Everyone.

The patented ACUdraw™ is the most advanced solution available on the market today for cocking a crossbow safely, quietly, and accurately. Fully integrated into the stock, with no dangling parts, it requires only the strength of the average person's index finger to operate. And, it only weighs slightly over one pound, unlike the competition's heavy and cumbersome add-on cocking devices. It allows hunters of all ages and physical abilities to enjoy the great experience of bowhunting.

New for 2002!

Based on advice from our customers, we now machine the string claw's center guide into the claw bottom (A) to achieve greater strength and stability. The claw bottom also contains our newly patented adjustable barrel guide cams. These cams allow you to adjust the claw to "custom fit" the barrel, further insuring precision loading when drawing the bowstring. We have also added a new claw holder for 2002 (B). The new holder stores the claw securely when it is not in use. It holds the claw in place even when you turn the crossbow upside down.

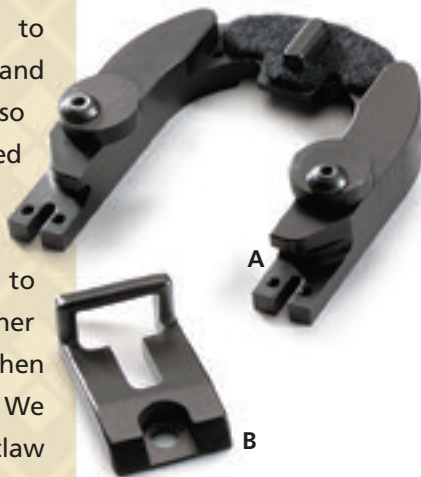

The Premier Cocking Mechanism Manufactured Today...

- Reduces draw weight to about 5 lbs. when operated manually
- Available installed in ALL TenPoint™ crossbow models
- Draws the bow consistently every time
- Cranks manually or powers-up with almost any cordless screwdriver or drill (4.2 volts or more)



ACUdraw™ Retrofit Program.

In addition to being available for all TenPoint crossbow models, the ACUdraw™ can be retrofitted on Excalibur, Buckmaster, and the Horton Yukon, Nitro Hunter, and older models using the Yukon and Nitro Hunter stock designs. Contact Customer Service at 330.628.9245 for details.

- Unlike other crossbow cocking mechanisms, it is lightweight and has **no bulky clamp-on assemblies or hang-on accessories**
- Belt holster for ACUdraw™ handle included

ACUdraw™ Stock-Only Program - Helps Dealers Control Inventory Expense

Stock-Only ACUdraw Unit, Mossy Oak® Break-Up™



HCA-003-A-MB

Dealers can purchase ACUdraw™ units mounted in stocks decorated in any of the camo patterns shown here. The Stock-only units can be interchanged with non-ACUdraw stocks when needed, thereby lowering inventory expense.

When a customer wants an ACUdraw™, the dealer simply removes the barrel from the crossbow model the customer selects, and installs it in an ACUdraw™ equipped stock. To replenish inventory, the dealer sends the unused stock back to TenPoint™ to have a new ACUdraw unit installed and shipped back.

Also available in the following patterns:

Realtree Hardwoods® HD™

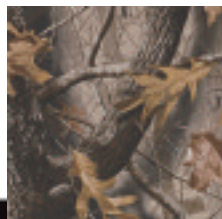

HCA-003-A-HW

Advantage Timber®

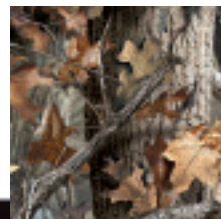

HCA-003-A-T

Skyline Apparition™

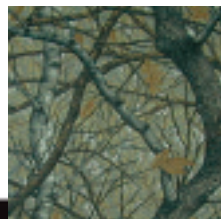

HCA-003-A-A

Realtree X-tra®

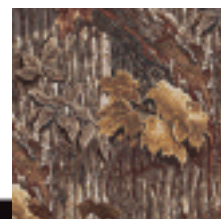

HCA-003-A-X

www.tenpointcrossbows.com

Stealth X-2



Product Numbers

HCB-004-2S
(with scope)

HCB-004-2
(without scope)

323 FPS

185 lb. Draw Weight



✓ **Limited Lifetime Warranty | ACUdraw Available | Core Performance Features Included**

The industry standard for design and performance.

Decorated in Realtree's® spectacular new Hardwoods® HD™ (High Definition) fluid-imaged camo, the **STEALTH X-2™** is the fastest and most powerful of TenPoint's top-of-the-line trio of advanced technology models. Its rich appearance mirrors its incomparable performance.

www.tenpointcrossbows.com

- Patented 3 1/2 lb. PowerTouch™ trigger assembly set at optimum travel and touch for a crisp, controlled release
- Fluid-imaged in Realtree's® **New** Hardwoods® HD™ camo
- ST™ quad-limbs with synthetic cables, and tunable yokes
- 65 Rockwell Hardcoated ACRA-ANGLE™ barrel impregnated with Teflon®
- RangeMaster® Rear Sight Adjustment Mechanism with 7/8" Weaver-style adjustable sight mount
- **New** Optional Dovetail Fixed Position Accessory (HCA-074) available to convert adjustable RangeMaster® Sight Mount to a fixed system
- CLAWOVER™ string release for superior accuracy
- **New** rock-solid five-point bow-to-barrel mounting system with tamper-resistant stainless steel mounting screws and aluminum tang
- **New** heavy-duty riser mounting rod and trigger housing-to-barrel clamp-plate, creating the strongest and most secure shooting platform in the industry.

Note:

The STEALTH is designed for use with a scope. You must purchase optional peep and pin conversion accessories to shoot it with pin sights.

Magnum X-2



Product Numbers

HCB-005-2S
(with scope)

HCB-005-2
(without scope)



316 FPS

175 lb. Draw Weight

Limited Lifetime Warranty | ACUdraw Available | Core Performance Features Included ✓

- Patented 3 1/2 lb. PowerTouch™ trigger assembly set at optimum travel and touch for a crisp, controlled release
- Fluid-imaged in the **New Advantage Timber®** camo
- ST™ quad-limbs with synthetic cables, and tunable yokes
- 65 Rockwell Hardcoated ACRA-ANGLE™ barrel impregnated with Teflon®
- RangeMaster® Rear Sight Adjustment Mechanism with 7/8" Weaver-style adjustable sight mount
- **New** Optional Dovetail Fixed Position Accessory (HCA-074) available to convert adjustable RangeMaster® Sight Mount to a fixed system
- CLAWOVER™ string release for superior accuracy
- **New** rock-solid five-point bow-to-barrel mounting system with tamper-resistant stainless steel mounting screws and aluminum tang

Note:

The Magnum is designed for use with a scope. You must purchase optional peep and pin conversion accessories to shoot it with pin sights.

Performance with an attitude.

The **MAGNUM X-2™** shooting in excess of 300 fps, approaches the speed and power of the **STEALTH**. It is fluid-imaged in the spectacular **NEW Advantage Timber®** camo and looks identical to its 150-pound partner, the **TURBO Extreme**. With an efficiently packaged 175-pound draw weight, it delivers with unquestionable authority and accuracy.

www.tenpointcrossbows.com

Turbo Extreme



Product Numbers

HCB-009-2S
(with scope)

HCB-009-2
(without scope)

293 FPS

150 lb. Draw Weight



✓ **Limited Lifetime Warranty | ACUdraw Available | Core Performance Features Included**

Unparalleled crossbow performance at 150-pounds.

There is no other 150-pound crossbow on the market today that can match the TURBO's flawless performance and rich good looks. With its near-300 fps speed, nail-driving accuracy, and its ultra smooth handling, the TURBO stands high above any would-be competitor in its weight class.

- Patented 3 1/2 lb. PowerTouch™ trigger assembly set at optimum travel for a crisp release
- Fluid-imaged in the **New** Advantage Timber® camo
- ST™ quad-limbs with synthetic cables, and tunable yokes
- 65 Rockwell Hardcoated ACRA-ANGLE™ barrel impregnated with Teflon®
- RangeMaster® Rear Sight Adjustment Mechanism with 7/8" Weaver-style adjustable sight mount
- **New** Optional Dovetail Fixed Position Accessory (HCA-074) available to convert adjustable RangeMaster® Sight Mount to a fixed system
- CLAWOVER™ string release for superior accuracy
- **New** rock-solid five-point bow-to-barrel mounting system with tamper-resistant stainless steel mounting screws and aluminum tang

Note:

The TURBO is designed for use with a scope. You must purchase optional peep and pin conversion accessories to shoot it with pin sights.

www.tenpointcrossbows.com

WoodsMan Plus



Product Number

HCB-021-2S
(with scope)

296 FPS

165 lb. Draw Weight

Limited Lifetime Warranty | ACUdraw Available | Core Performance Features Included

- TL-4™ quad-limbs with steel cables, and tunable yokes
- Fluid Imaged in Realtree X-tra® camo
- Black anodized ACRA-ANGLE™ barrel
- Optional 7/8" fixed Weaver style dovetail available
- Patented 3 1/2 lb. PowerTouch™ trigger assembly
- CLAWOVER™ sting release
- **New** rock-solid five-point bow-to-barrel mounting system with tamper-resistant stainless steel mounting screws and aluminum tang

Note:

TenPoint's Fixed 7/8" Dovetail Sight Mount accessory (HCA-078) is required to mount a scope. When the crossbow is purchased from the factory with TenPoint's 4-Power x 28mm Mini-Crossbow Scope (HCB-021-2S), the sight mount is included. When purchased without a scope (HCB-021-2), the WoodsMan Plus™ comes with a peep and pin sighting system.

The no-frills approach to high-end performance.

Positioned between our top-line and entry-level models, the **WoodsMan Plus™** delivers raw power and pinpoint accuracy with no-frills pricing. Built with TenPoint's top-line, patented PowerTouch™ trigger and its unique Core Performance Features, the WoodsMan Plus™ is the perfect choice for hunters looking for affordable high-end performance.

www.tenpointcrossbows.com

Titan

Product Number
HCB-030



296 FPS

165 lb. Draw Weight



✓ **Limited Lifetime Warranty | ACUdraw Available | Core Performance Features Included**

The best entry-level purchase available in the industry today... period.

With all of TenPoint's Core Performance Features and its own unique trigger mechanism and plunger safety, the very affordable TITAN™ defies its classification as an entry-level model by outclassing and outperforming other brands' top-line models.

www.tenpointcrossbows.com

- Crisp drop-latch trigger with ambidextrous plunger safety
- Fluid imaged 11-color Skyline Apparition™ camo
- FST IV™ stock with functionally superior thumbhole
- TL-4 quad limbs with steel cables and tunable synthetic yokes
- Black anodized ACRA-ANGLE™ barrel
- Fixed sight bridge with peep sight
- Scope compatible. Optional 7/8-inch Fixed Dovetail Sight Mount (HCA-078) required
- **New** rock-solid five-point bow-to-barrel mounting system with tamper-resistant stainless steel mounting screws and aluminum tang

Simplify your purchase by selecting the value-added TITAN™ Package (HCB-030-P) or TITAN™ ACU-draw™ Package (HCB-030-AP)

- TITAN™ Crossbow or TITAN™ ACUdraw™ Crossbow
- Instant Detach 2/3 Arrow Quiver and three E-Hunter™ Arrows with 125 grain field points
- TenPoint™ Staff Shooter Field Cap



Titan SE



Product Number
HCB-035-2

NEW



258 FPS

150 lb. Draw Weight

Limited Lifetime Warranty | ACUdraw Available | Core Performance Features Included ✓

- Two-inch shorter barrel than our other models
- Crisp drop-latch trigger with ambidextrous plunger safety
- Fluid imaged 11-color Skyline™ Apparition™ camo
- FST IV™ stock with functionally superior thumbhole
- TL-4 quad limbs with steel cables and tunable synthetic yokes
- Black anodized ACRA-ANGLE™ barrel
- Fixed sight bridge with peep sight
- Scope compatible. Optional 7/8-inch Fixed Dovetail Sight Mount (HCA-078) required
- **New** rock-solid five-point bow-to-barrel mounting system with tamper-resistant stainless steel mounting screws and aluminum tang

Simplify your purchase by selecting the value-added TITAN SE™ Package (HCB-035-2P) or TITAN SE™ ACU-draw™ Package (HCB-035-2AP)

- TITAN SE™ or TITAN SE™ ACUdraw™ Crossbow
- Instant Detach 2/3 Arrow Quiver and three E-Hunter™ Arrows with 125 grain field points
- TenPoint™ Staff Shooter Field Cap

**NEW for 2002,
a two-inch shorter,
150 lb. companion
to the Titan.™**

The **NEW TITAN SE™** offers top-of-the-line engineering and performance at entry-level prices for young hunters, women, and others wanting a lighter, shorter and lighter draw weight crossbow.

www.tenpointcrossbows.com

Crossbow Arrows

A complete line of nock systems for most crossbows.

- A** PSE Nocks (old & new) for 2219 shafts
- B** Polymer blunt nocks (black & silver) for 2315 & 2117 shafts
- C** SuperBrite™ nock for 2216 & 2219 shafts
- D** Barnett & Horton CPC Moon Nocks for 2216 & 2219 shafts
- E** Bear/Jennings nocks for 2219 shafts

Patented SuperBrite™ nock tool available for refletching of arrows with SuperBrite™ nocks.



TenPoint Crossbow Technologies™ has the shaft, insert, and nock combination for most crossbows on the market or in the field today. Check with your local dealer for the optimum combination for your crossbow.

As Easton Aluminum's Complete Crossbow Arrow Resource, TenPoint Crossbow Technologies™ combines the art and tradition of fletching arrows with the unparalleled quality of Easton shafts to produce the highest quality crossbow arrows available today.



Four TenPoint™ Models In Four Shaft Sizes Available:

- XX75 TenPoint™ Camo, 2219, 2216, & 2117. This three-color camo shaft is the proven industry standard for absolutely reliable results. The 2219 is available in all nock systems. The 2216 is available with our patented TenPoint™ SuperBrite™ blunt cap and the Barnett & Horton CPC moon nock. The 2117, for Excalibur bows, uses a black polymer blunt cap.
- XX75 Magnum Series™ 20-inch, 2315. An olive drab shaft with silver polymer blunt end and CPC insert. With a bit less weight and a bit more diameter, a choice for those target shooters or hunters looking for more velocity and a slightly larger diameter.
- XX78 TURBO EX 20-inch, 2219 with the patented SuperBrite™ neon polymer blunt end and carbon point insert. A super-strong, super-straight arrow in Easton's best alloy. Finished in TenPoint's™ Camo.
- 5086 E-Hunter™. Available in two sizes: 2219 & 2216 with either SuperBrite™ or Barnett & Horton CPC Moon Nocks. This all black economy shaft provides incredible performance at the right price.

String & Cable Reference Guide

Crossbows	STRINGS			CABLES				
	HCA -115	HCA -117	HCA -119	HCA -120	HCA -122	HCA -124	HCA -125	HCA -126
HuntsMan 1994 -1997		■					■	
HuntsMan 1998		■						■
HuntMaster (w/o yokes) 1994 -1995	■			■				
HuntMaster (w/ yokes) 1995 -1997	■				■			
HuntMaster TL-4 1998	■					■		
458 Magnum 1996 -1997			■			■		
458 Magnum TL-4 1998 -1999	■					■		
WoodsMan 1998		■						■
WoodsMan Plus & WoodsMan SE		■						■
Titan & Titan SE		■						■
Turbo Extreme	■					■		
Magnum Extreme	■					■		
Magnum X-2	■					■		
Stealth X-2	■					■		

All Bow. No Bull with TenPoint™ Crossbows

The performance chart below contains data from tests we conducted using the crossbows and arrows shown. All the crossbows were production models. We did not increase draw weights or modify any of the bows. All of the arrows were 20" Easton® XX75 shafts equipped with carbon CPC inserts, TenPoint's™ SuperBrite™ neon tracer blunt nocks and traditional turkey-feather fletching.

20" Arrow Type / Weight	Stealth X-2™	Magnum X-2™	Turbo Extreme™	WoodsMan Plus™	Titan™	Titan SE™
2216 XX75 / 378 Grains	323 fps 87.6 fp	316 fps 83.8 fp	293 fps 72.1 fp	296 fps 73.6 fp	296 fps 73.6 fp	258 fps 55.9 fp
2315 XX75 / 381 Grains	322 fps 87.7 fp	314 fps 83.4 fp	290 fps 71.2 fp	295 fps 73.6 fp	295 fps 73.6 fp	256 fps 55.5 fp
2219 XX75 / 416 Grains	312 fps 90.0 fp	304 fps 85.4 fp	283 fps 74.0 fp	285 fps 75.1 fp	285 fps 75.1 fp	245 fps 55.5 fp
Feet Per Second (fps) Foot Pounds (fp)						

www.tenpointcrossbows.com

We urge you to shoot 2219 shafts (or shafts of comparable weight) when using any crossbow. Using lighter shafts may damage your crossbow over time and will void your TenPoint warranty. The lighter shafts shown above were tested only to provide you with a basis for comparing TenPoint crossbow speed with crossbows manufactured by others tested with similar lightweight arrows.

Accessory Packages

Save money, simplify your purchase, and take to the woods fully equipped. These accessory packages are tailored to fit your needs. **Free practice points included with all packages (HEA-301).**

Realtree Hardwoods® Pak (HCA-RPK) includes:

- HCA-202 Deluxe 2-Pocket Realtree Hardwoods® Case
- HCA-019 Instant Detach 4-Arrow Front Mount Realtree Hardwoods® Quiver
- HEA-300 Thunderhead® 125 Broadhead 6-pack
- HEA-002.6 XX75 Camo Crossbow Arrows – 6-pack
- HCA-002-HW Deluxe Sling w/swivels
- HCA-111 Flight Rail & Trigger Lube
- HCA-110 String & Cable Wax



Realtree Hardwoods®

Realtree Hardwoods® EXP Pak (HCA-RPK-EXP)

Same as above with Spitfire® 125-grain Broadhead 3-Pack (HEA-299), in place of Thunderhead™ 125 Broadhead 6-pack.
HCA-014-HW Expandable Broadhead Quiver in place of HCA-019.



Mossy Oak® Break-Up™ Pak (HCA-BPK) includes:

- HCA-201 Deluxe Mossy Oak® Break-Up™ Case
- HCA-018 Instant Detach 4-Arrow Front Mount Mossy Oak® Break-Up™ Quiver
- HEA-300 Thunderhead® 125 Broadhead 6-pack
- HEA-002.6 XX75 TenPoint's™ Camo Crossbow Arrows – 6-pack
- HCA-008 Deluxe Mossy Oak® Break-Up™ Sling w/swivels
- HCA-111 Flight Rail & Trigger Lube
- HCA-110 String & Cable Wax



Mossy Oak® BREAK-UP™ EXP Pak (HCA-BPK-EXP)

Same as above with Spitfire® 125-grain Broadhead 3-Pack (HEA-299), in place of Thunderhead® 125 Broadhead 6-pack.
HCA-014-MB Expandable Broadhead Quiver in place of HCA-018.



Advantage Timber® Pak (HCA-TPK) includes:

- HCA-203-T Deluxe 2-Pocket Advantage Timber® Case
- HCA-016-T Instant Detach 4-Arrow Front Mount Advantage Timber® Quiver
- HEA-300 Thunderhead® 125 Broadhead 6-pack
- HEA-002.6 XX75 Camo Crossbow Arrows – 6-pack
- HCA-002-T Deluxe Sling w/swivels
- HCA-111 Flight Rail & Trigger Lube
- HCA-110 String & Cable Wax

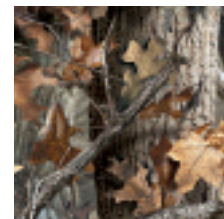

Advantage Timber®

Advantage Timber® EXP Pak (HCA-TPK-EXP)

Same as above with Spitfire® 125-grain Broadhead 3-pack (HEA-299), in place of Thunderhead® 125 Broadhead 6-pack.
HCA-014-T Expandable Broadhead Quiver in place of HCA-016-T.



ECONO Pak (HCA-WPK-2) includes:

- HCA-016 Instant Detach Front Mount Black Quiver
- HCA-002 Deluxe Black Sling w/swivels
- HEA-002.6 XX75 TenPoint's™ Camo Crossbow Arrows – 6-pack
- HCA-111 Flight Rail & Trigger Lube
- HCA-110 String & Cable Wax



Accessories

Slings



HCA-008 Deluxe Mossy Oak® Break-Up™ Sling w/swivels

The Deluxe Sling is also available in the following patterns:

HCA-002-T Advantage Timber®

HCA-002-HW Realtree Hardwoods®

HCA-002 Black

The Deluxe Slings are unparalleled in quality and construction. They feature a longer design with non-slip; double thick reinforced shoulder pads and heavy-duty adjustable nylon straps (swivels included).

Quivers

2/3 Arrow Expandable Broadhead Instant Detach Quiver (Exclusive to TenPoint)

HCA-014-HW Instant Detach 2/3-Arrow Front Mount Realtree Hardwoods® Quiver for Expandable Broadheads

The 2/3 Arrow Expandable Broadhead Instant Detach Quiver is also available in the following patterns:

HCA-014-MB Mossy Oak® Break-Up™ (see camo swatch)

HCA-014-T Advantage Timber® (see camo swatch)

HCA-014 Black

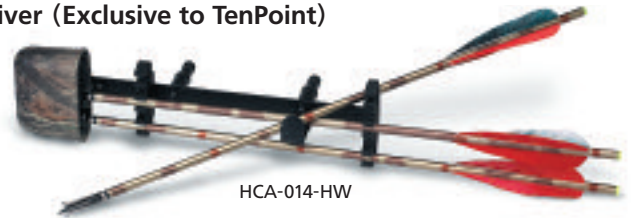

2/3 Arrow Fixed Broadhead Instant Detach Quiver

HCA-015-MB Instant Detach 2/3-Arrow Front Mount Mossy Oak® Break-Up™ Quiver for Fixed-Blade Broadheads

The 2/3 Arrow Fixed Broadhead Instant Detach Quiver is also available in the following patterns:

HCA-015-HW Realtree Hardwoods® (see camo swatch)

HCA-015-T Advantage Timber® (see camo swatch)

HCA-015-A Skyline™ Apparition™ (see camo swatch)

HCA-015 Black



4/5 Arrow Instant Detach Quiver

HCA-019 Instant Detach 4/5-Arrow Front Mount Realtree Hardwoods® Quiver

The 4/5 Arrow Fixed Broadhead Instant Detach Quiver is also available in the following patterns:

HCA-018 Mossy Oak® Break-Up™ (see camo swatch)

HCA-016-T Advantage Timber® (see camo swatch)

HCA-016 Black



All of TenPoint's quivers feature our instant detach design so you can quietly and quickly attach and detach them by tightening or loosening two lock-down knobs. Available in 2/3 arrow and 4/5 arrow designs with an expandable broadhead design in the 2/3 arrow version.

www.tenpointcrossbows.com

Crossbow Cases

HCA-201 Deluxe 2-Pocket Mossy Oak® Break-Up™ Case

The Deluxe 2-Pocket Case is also available in the following patterns:

HCA-202 Realtree Hardwoods® (see camo swatch)

HCA-203-T Advantage Timber® (see camo swatch)

The best looking and most durable crossbow cases made today. With extra-thick padding, heavy-duty zippers, and two pockets for extra arrows and miscellaneous accessories, these soft cases will protect your investment for years to come. Check your state's regulations. Some require all crossbows to be transported in a case.



Scopes

HCA-083 30mm Red Dot Scope w/ 3/8" mounting rings

HCA-084 30mm Red Dot Scope w/ 7/8" mounting rings



The best value in an illuminated red dot scope on the market today. With eleven brightness settings and its all-aluminum construction, this zero-power scope comes with a tube extension lens shade and 3/8" or 7/8" mounting rings. Delivers pinpoint accuracy in all light conditions.

HCA-085 4-Power x 1" MINI Crossbow Scope w/3/8" mounting rings

HCA-094 4-Power x 1" MINI Crossbow Scope w/7/8" mounting rings

HCA-090 2-6 Power x 1" MINI Crossbow Scope w/ 3/8" mounting rings

HCA-091 2-6 Power x 1" MINI Crossbow Scope w/ 7/8" mounting rings



Perfectly proportioned for a crossbow at only 7" long, these light, compact scopes feature fully-coated optics, duplex cross hairs, and all-aluminum construction. An exceptional value, they can be ordered with either 3/8" or 7/8" mounting rings.

Camo Swatch Reference for Accessories



Realtree Hardwoods® HD™

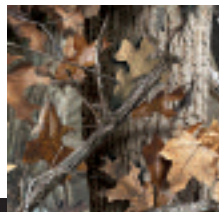

Advantage Timber®



Skyline Apparition™

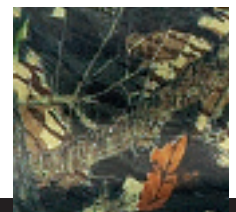

Mossy Oak® Break-Up™

Sight Mounts

- HCA-075-H 3/8" Adjustable Dovetail Sight Mount / Hardcoat
 HCA-077-H 7/8" Adjustable Dovetail Sight Mount / Hardcoat
 HCA-078 7/8" Fixed Dovetail Sight Mount / Black

Our STEALTH, MAGNUM, and TURBO cross-bow models come standard with our adjustable 7/8" dovetail (HCA-077-H) but will accept our adjustable 3/8" dovetail (HCA-075-H), which is needed if you wish to convert to a peep and pin sighting system. When adding a scope to the WoodsMan or TITAN models, you must purchase our optional fixed position 7/8" dovetail (HCA-078). Both 7/8" dovetails are Weaver style mounts.



Dovetail Fixed Position Accessory for RangeMaster®

- HCA-074 Dovetail Fixed Position Accessory for RangeMaster®



For STEALTH, MAGNUM, or TURBO owners who wish to convert their Adjustable RangeMaster® Sight Mount System into a fixed or permanent system. This accessory, along with a few parts from the RangeMaster® system, replaces the RangeMaster® thumb lever and locks the sight mount solidly in a fixed position.

Peep and Pin Conversion Kit

- HCA-071 Peep and Pin Conversion Kit



For STEALTH, MAGNUM, or TURBO owners who wish to convert to a peep and pin sighting system. Simply replace the standard 7/8" dovetail with the kit's 3/8" version. Then, attach the peep and front pin assembly.

Scope Rings

- HCA-080 1" Scope Rings w/ 3/8" Base
 HCA-081 1" Scope Rings w/ 7/8" Base (not pictured)
 HCA-082 30mm Scope Rings w/ 3/8" Base (not pictured)
 HCA-092 30mm Scope Rings w/ 7/8" Base (not pictured)



Regardless of the scope you wish to mount or the size dovetail you choose to have on your crossbow, we have the rings to handle the job.

Sights

- HCA-041 Front Sight Bracket w/Pin
 HCA-060 Rear Peep Sight (requires 3/8" dovetail scope mount)

Standard on the TITANS™ and non-scoped WoodsMan™, where it mounts in a fixed position. When purchased for use with the adjustable 3/8" dovetail, it mounts anywhere along the length of the rail.



Standard on TITANS™ and non-scoped WoodsMan™, this sturdy machined aluminum sight bracket features two pin slots and can be mounted on either side of the riser. Comes with one pin. Additional pins available

Lubricants

- HCA-110 String & Cable Wax
- HCA-111 Flight Rail & Trigger Lube



These two lubricants are critical to maintaining all crossbows in good working order and to extending the life of your strings and cables. The Flight Rail Lube, unlike other manufacturers' gel-based lubricants, will not freeze-up in cold weather nor collect dirt and grit, which could make your trigger sluggish and impede its performance.

Crossbow Press

- HCA-106 Portable Crossbow Press

Easy to use, the Portable Crossbow Press is the perfect, cost-effective way for dealers or owners who choose to do their own crossbow string & cable maintenance, tuning and repair.



ACUdraw™ Claw Kit

- HCA-427 ACUdraw™ Claw Kit



Featuring a new Claw Holder (HCA-426), which replaces the aluminum insert holder, and a new Claw Bottom (HCA-425), outfitted with our new patented barrel alignment cams and a guide, now machined into and part of the claw. It is no longer necessary to tighten the draw cords when the claw is in its storage position. The new holder even allows you to turn the bow upside down without the claw falling out. The new cams further insure consistent precision loading of the bowstring. Free replacement Draw Cord (HCA-401) included with every kit.

Sighting Accessories *(not pictured)*

- HCA-086 RangeMaster® Sight Adjustment Mechanism
- HCA-050 Standard Sight Pin

Shooting Aids

- HCA-113 Standard Cable Saver
- HCA-114 Extreme Cable Saver
- HEA-299 New Archery Products' Spitfire® 125-grain, 3-Blade Mechanical Broadhead 3-pack
- HEA-300 New Archery Products' Thunderhead® 125-grain Fixed Broadhead 6-Pack



ACUdraw™ Replacement Accessories *(not pictured)*

- HCA-430 Replacement Hand Crank
- HCA-440 Replacement Crank Holster
- HCA-400 Replacement Draw Cords (prior to 1998)
- HCA-401 Replacement Draw Cords
- HCA-411 Replacement Retraction Spring
- HCA-421 **New** - Replacement Draw Claw w/cord

Better, Stronger, and More Accurate in 2002

In our pursuit of perfection... continuous improvement is an ongoing requirement. We have improved our crossbows every year since our inception in 1994. This year is no exception. Our 2002 models are better, stronger and more accurate than ever.

As draw weights have increased, it has become necessary to build models that can handle the increased energy that they produce. On this year's **STEALTH X-2™**, we have strengthened the connection between the bow assembly and the stock assembly with a new heavy-duty riser rod. At the other end of the barrel we have designed a double-duty clamp plate to strengthen the connection between the trigger and the barrel and the barrel and the stock.

On all of our 2002 models we now have a new five-point barrel-to-stock connection system for added strength, employing tamper-resistant stainless steel connectors and replacing the polymer tang with an aluminum version. The 2002 **STEALTH X-2™** offers the most solid and stable shooting platform in the industry.

For customers who want the performance and features of our top-of-the-line models but prefer a fixed position sight mount, we have designed a fixed-position accessory to replace the adjustable RangeMaster® system. With the help of a couple of the RangeMaster® parts, this new accessory completely immobilizes the dovetail sight mount.

We continue to make improvements to our patented ACUdraw™ automated cocking unit. This year we have introduced a new claw holder that mounts behind the trigger box. The new holder holds the claw in place without having to crank the draw cords taut. We have

also created a new bottom for the claw featuring a machined center guide, which eliminates the previous bolt-secured brass guidepost. The bottom further features two newly **patented** adjustable barrel-guide cams. The cams allow you to adjust the claw to custom-fit the barrel, further insuring precision loading of the crossbow string. These ACUdraw improvements are available as an upgrade accessory kit.

Barrel construction and dimension integrity is critical to shooting accuracy. The barrel flight deck and the arrow flight groove are now machine-finished on all of our crossbows, further enhancing arrow flight and shooting accuracy. No other crossbow on the market is made with this level of barrel accuracy.

Finally, we have improved the appearance of our 2002 models. We have laser-engraved our name on the barrel of each crossbow. And, for every model except the **Titan**, we have added new, detail rich camouflage patterns.

The 2002 **WoodsMan Plus™** comes in Realtree X-tra®, one of the most recognized patterns in the industry. The **STEALTH X-2™** now features Realtree's spectacular new Hardwoods® HD™ high definition camo, providing incredible photo-realism, depth, and classic good looks to the industry's top performing crossbow. The **MAGNUM X-2™** and the **TURBO EXTREME™** models come in Advantage Timber® for 2002. Featured on the cover of this catalog, Advantage Timber's® warmth and richness appropriately compliments the fine quality of these two models.

At TenPoint the best keeps getting better. You can count on it.



...the mark of perfection™

TenPoint Crossbow Technologies™
1325 Waterloo Road Suffield, OH 44260-9608
Phone: 330.628.9245
Fax: 330.628.0999
www.tenpointcrossbows.com

Note: The proprietary products shown in this catalog are protected under the following TenPoint Crossbow Technologies® patents and any patents pending: U.S. Patent No's. 5,553,596; 5,598,829; 5,649,520; 5,987,724; 6,095,128; 6,286,496 B1.

Note: TenPoint Crossbow Technologies™ reserves the right to alter crossbow specifications during any model year.

© Copyright 2002 TenPoint Crossbow Technologies.

